

## Absolut Stabilitet

- at opnå direkte heling

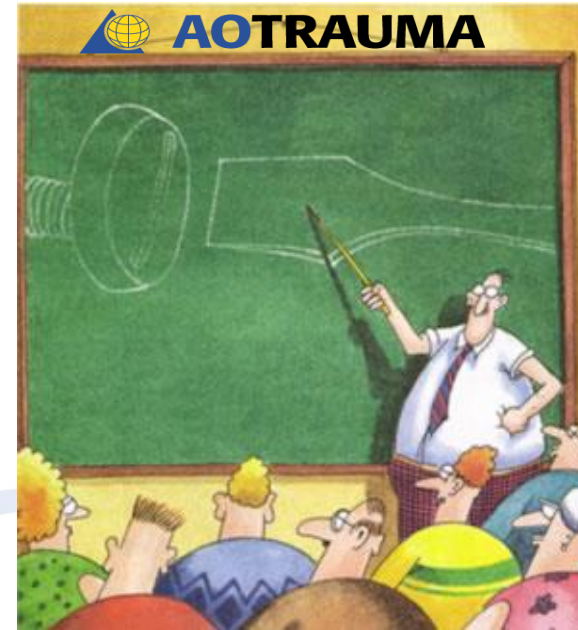

Anders Jordy

Kolding Sygehus

AO – basale principper

Fredericia, april 2023

# Absolut stabilitet?

- Er ikke et spørgsmål om en *absolut* mængde isenkram
- Billeder fra
  - Watson – Jones: Fractures and Joint Injuries, 1955

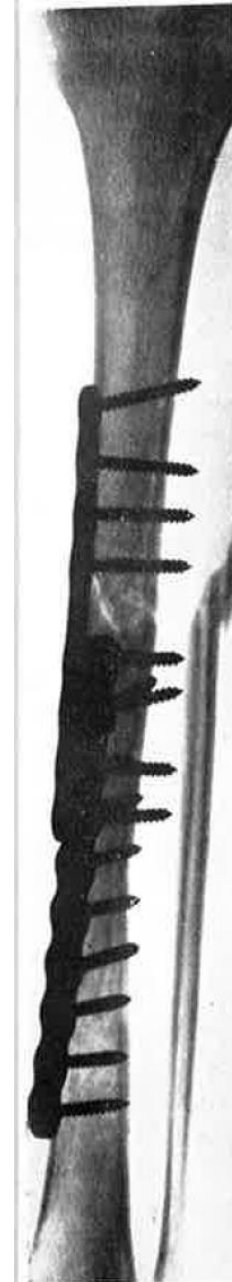

FIG. 352



- Er ikke et spørgsmål om en *absolut* mængde isenkram
- Men om korrekt teknik
- Billeder fra
  - Watson – Jones: Fractures and Joint Injuries, 1955





# Absolut stabilitet?

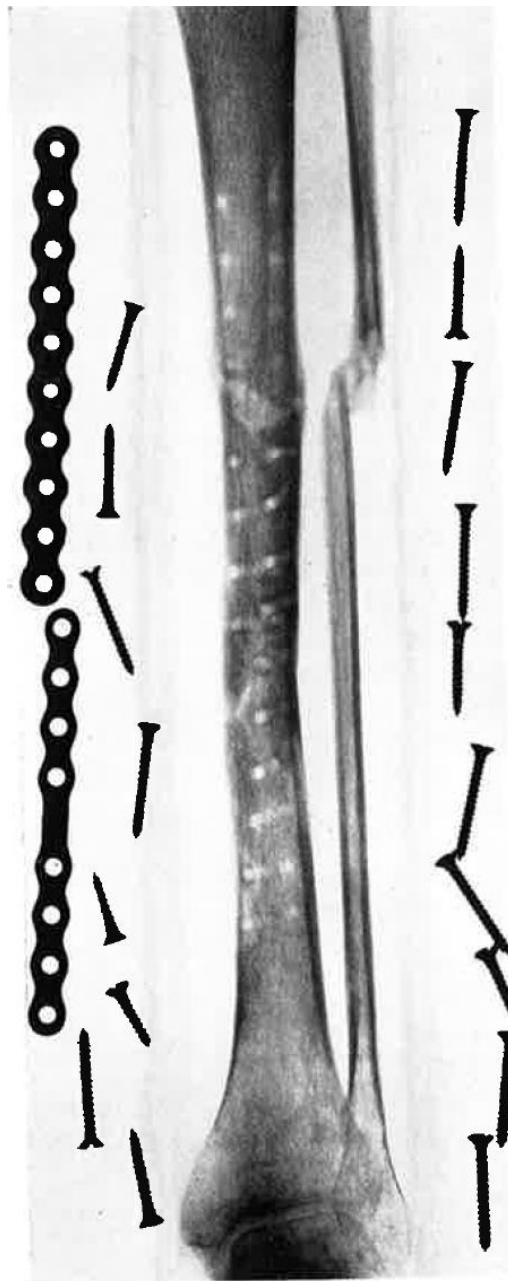
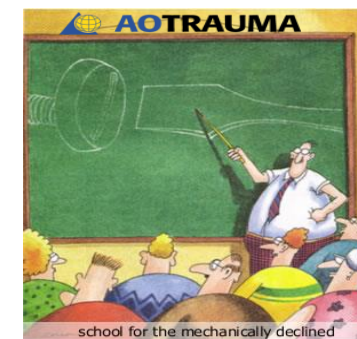

FIG. 353



FIG. 354



# Absolut stabilitet?



A technician, who called himself surgeon, found it possible to introduce eighteen screws and two plates into one simple fracture of the tibia (Fig. 352). More bone was destroyed by the operation than by the original fracture. Thereafter the unfortunate patient sustained five spontaneous fractures through the sites of drill holes (Fig. 354). Only after three years could he step off a pavement with some assurance that his shin would not crack beneath him. The joys of operative craftsmanship must not be indulged: the driving of screws with power-driven tools is great fun, but it is a pleasure that must be denied.

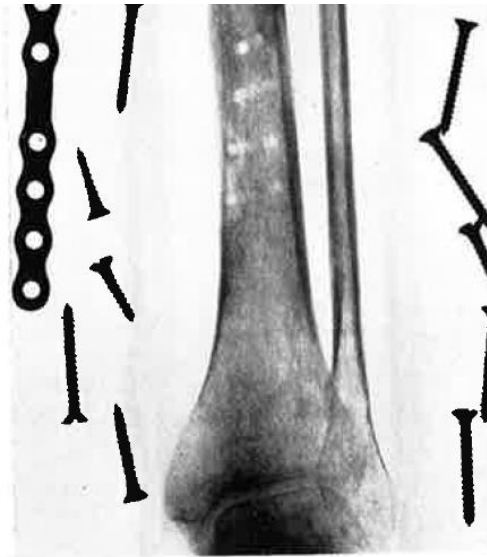

FIG. 353

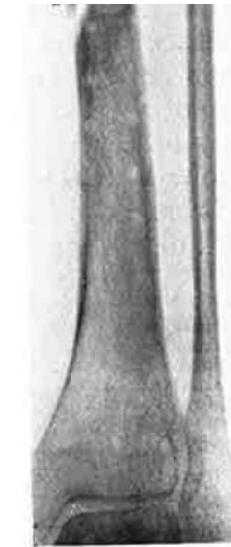
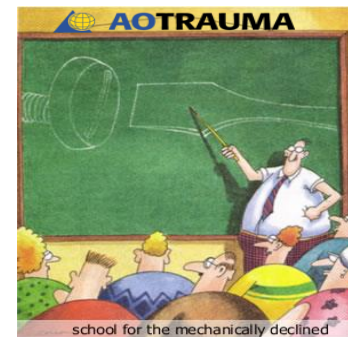
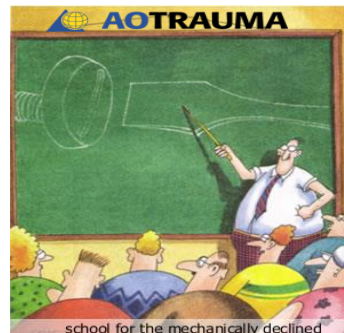

FIG. 354



# Læringsmål

- Hvad vil absolut sige?
- Knoglebiologi i relation til absolut stabilitet
- Indikationer – hvornår er det ønskværdigt at opnå absolut stabilitet?
- Måder at opnår absolut stabilitet:
  - Lagprincippet
  - Kompressionsskinne
  - Tension band
  - Buttress



# Strain theory of healing (Stephan Perren)

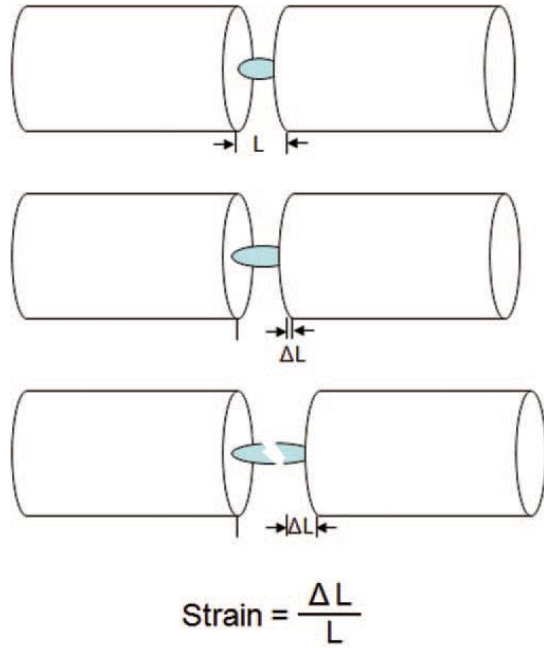

**Absolute stability: < 2% strain**

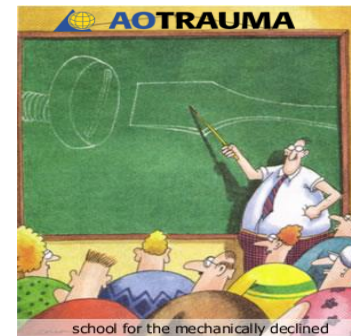
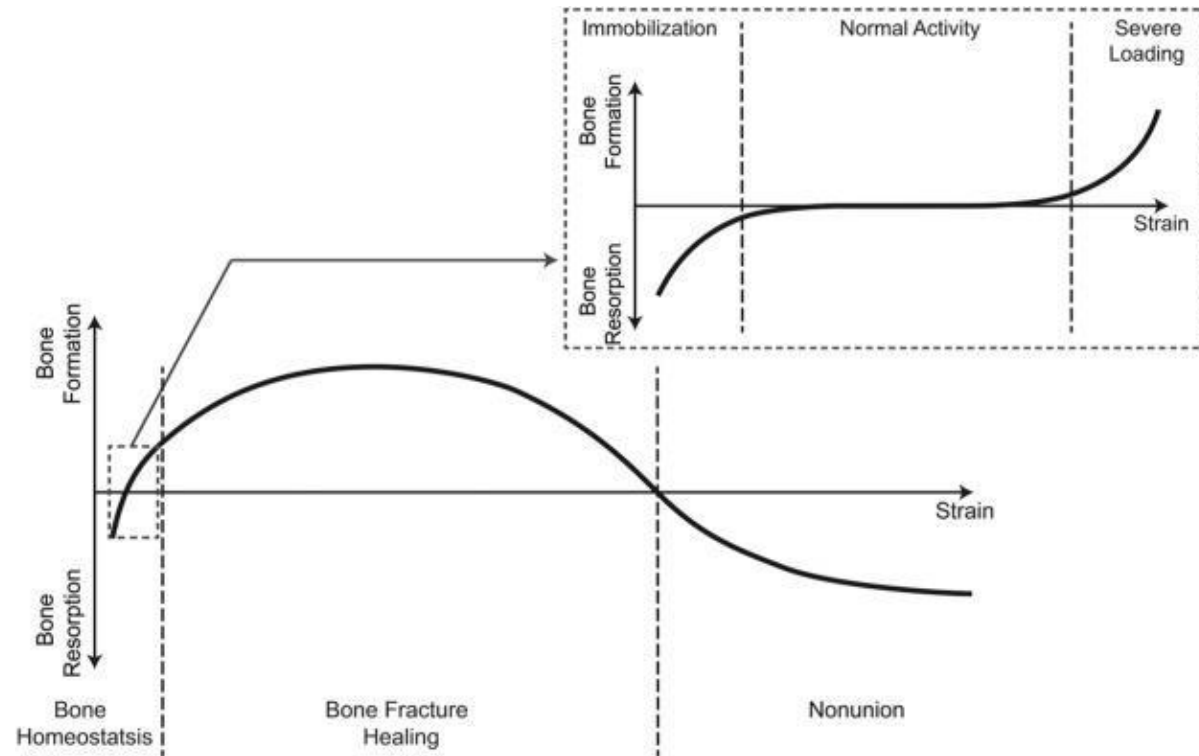



# absolute stability

osteoblasts and osteoclasts will not recognize the fracture-gap.....

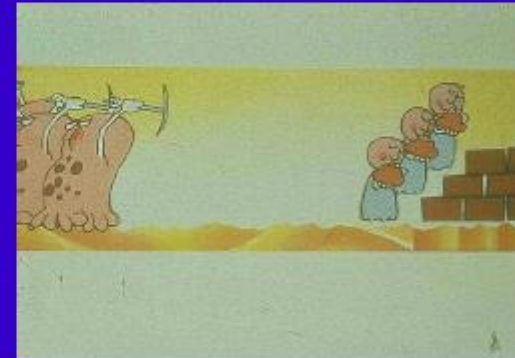
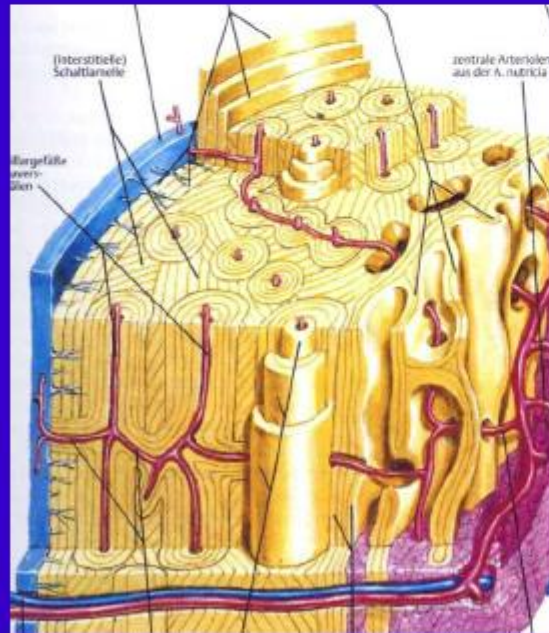

# absolute stability

osteoblasts and osteoclasts will not recognize the fracture-gap, ...cross it and the fracture will be repaired by primary (direct) bonehealing

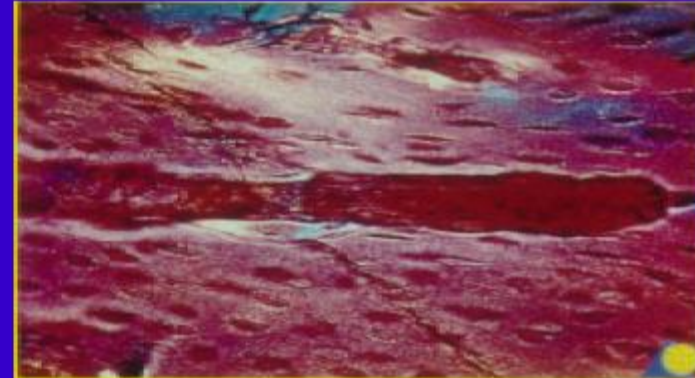
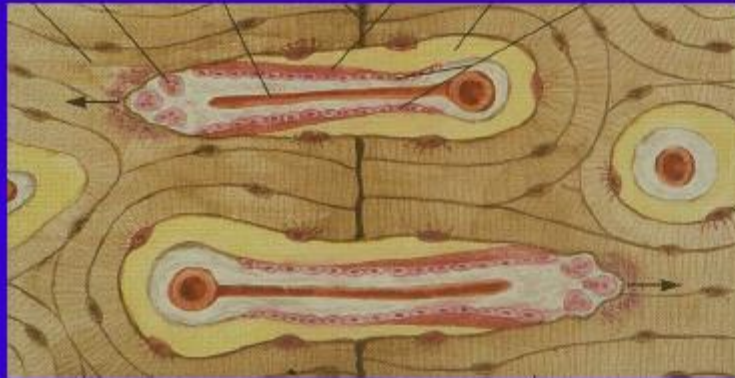

# For at opnå absolut stabilitet kræves...

1. Interfragmentær kompression
2. og sikker stabilisering af frakturen der modvirker interfragmentær bevægelse



# Hvornår ønskes absolut stabilitet?



# Hvornår ønskes absolut stabilitet?

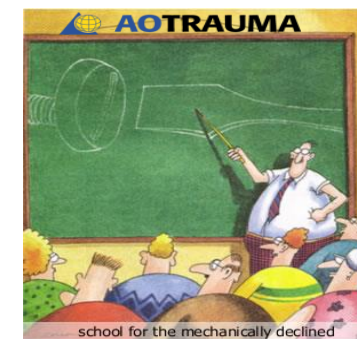

# Hvornår ønskes absolut stabilitet?

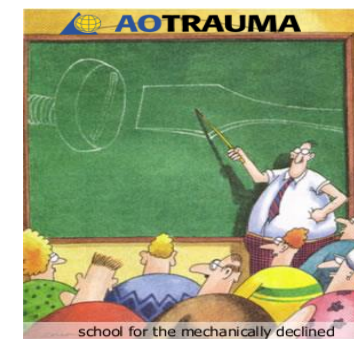
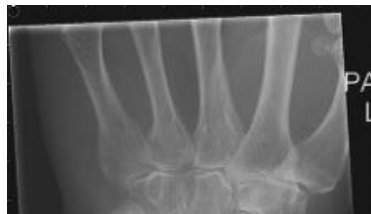

# Fire metoder der giver absolut stabilitet

1. Skruer, der isættes med lag-teknik
2. Kompressionsskinner
3. Tension band
4. Buttress

- Interfragmentær kompression
- sikker stabilisering af frakturen der modvirker interfragmentær bevægelse

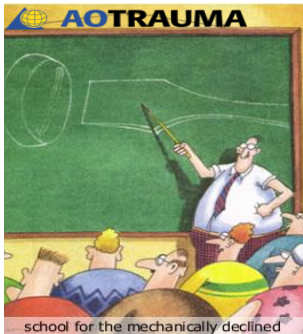
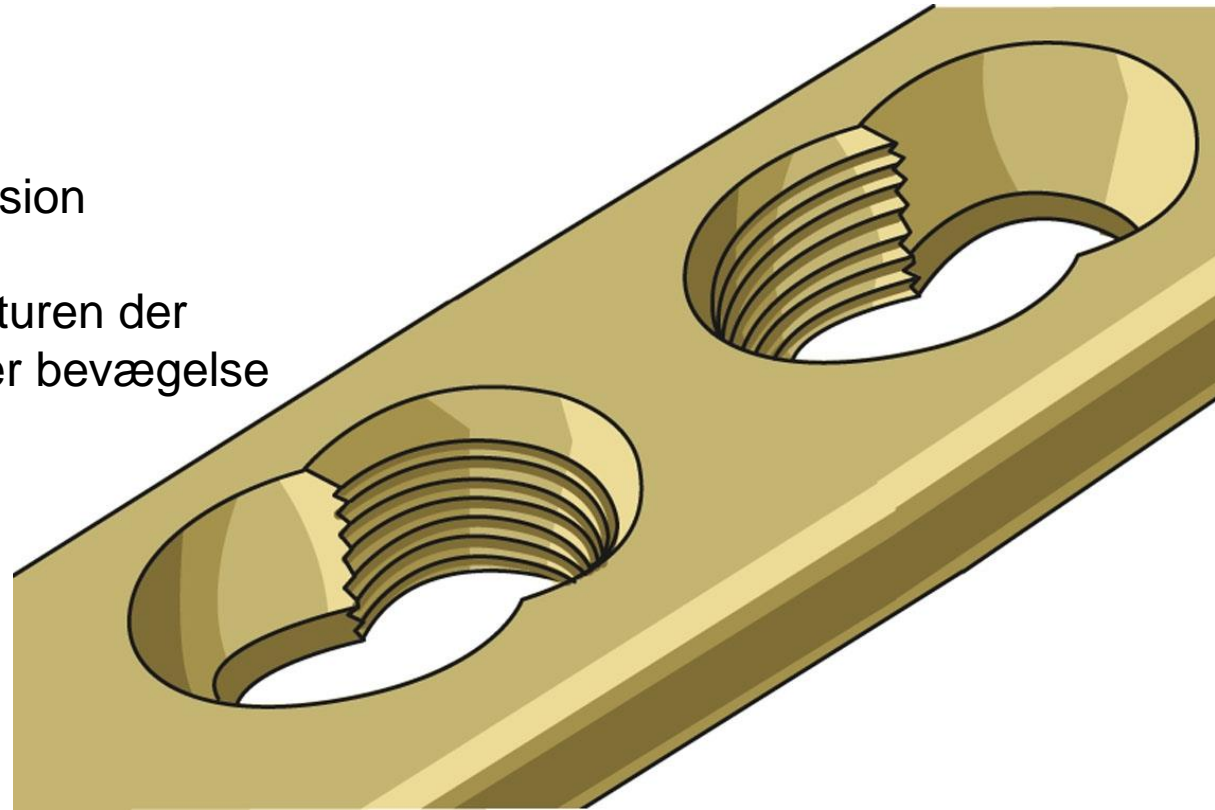

# 1. Hvad er "lag"?

**lag**<sup>1</sup>  [lag]  [Show IPA](#) **verb, lagged, lag·ging, noun**

**verb (used without object)**

1. to fail to maintain a desired pace or to keep up; fall or stay behind: *After five minutes of hard running, some of them began to lag.*
2. to move or develop slowly, as toward a goal or objective, or in relation to an associated factor (often followed by *behind*): *to lag behind in production.*
3. to delay or fail in reaching full development: *The factory lags regularly in making its quota.*
4. to hang back; linger; delay: *The old friends lagged because they wanted to talk some more.*
5. to decrease, wane, or flag gradually, as in intensity: *Interest lagged as the meeting went on.*
6. *Marbles* . to throw one's shooting marble toward a line (**lag line**) on the ground in order to decide on the order of play.
7. *Billiards, Pool* . string ( def. 17b ) .

**verb (used with object)**

8. to fail to keep up with: *The industry still lags the national economy.*
9. *Obsolete* . to cause to lag.

**noun**

10. a lagging or falling behind; retardation.
11. a person who lags behind, is the last to arrive, etc.
12. an interval or lapse of time: *There was a developmental lag in the diffusion of ideas.*
13. *Mechanics* . the amount of retardation of some motion.
14. *Electricity* . the retardation of one alternating quantity, as current, with respect to another related alternating quantity, as voltage, often expressed in degrees.
15. *Marbles, Billiards* . the act of lagging.

**Origin:**

1505-15; < Scandinavian: compare Norwegian *lagga* to go slowly

**Synonyms**

1. loiter, linger. 10. slowing, slowdown.

**Antonyms**

1. hasten.

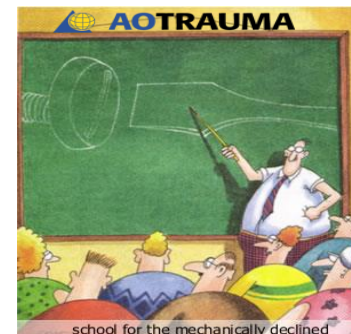



# 1. Lag princip

- En skrue der isættes så den giver kompression over frakturlinien
- Et princip – ikke en skrue!

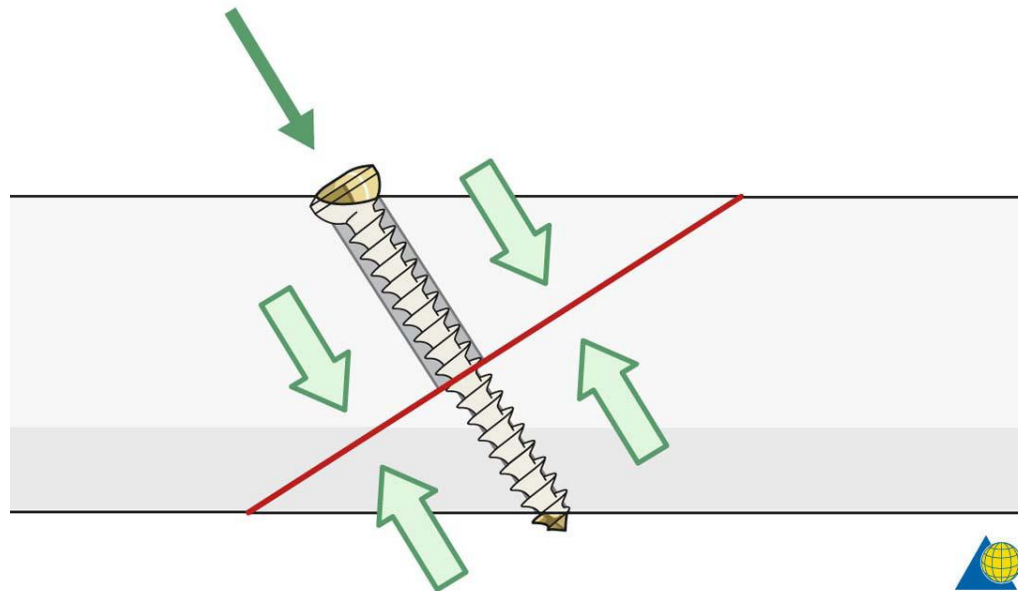

# 1. Lag by technique

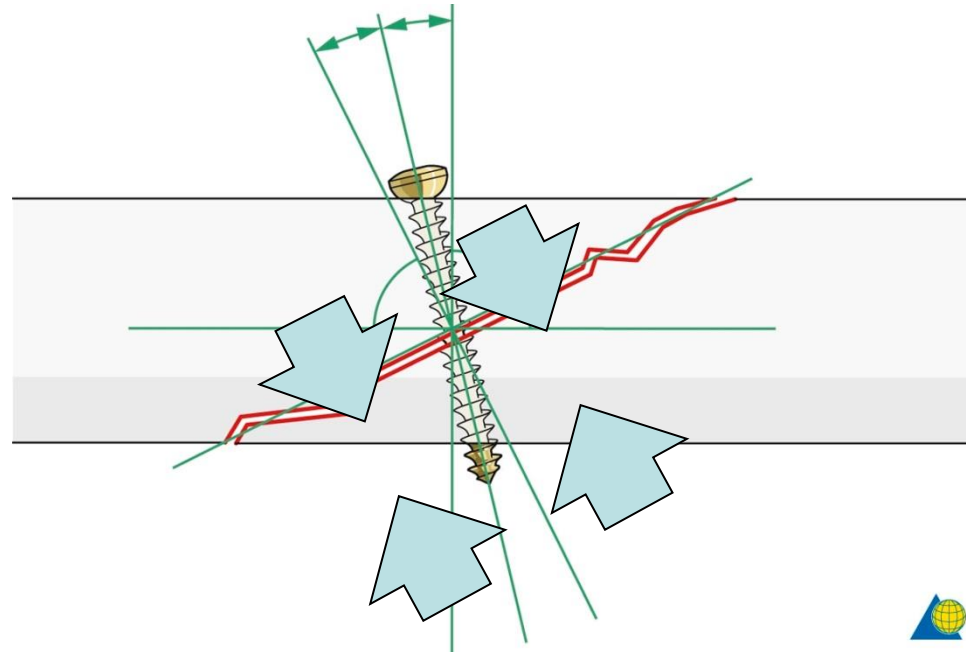
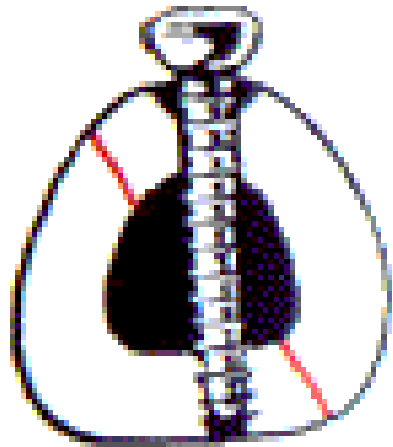

# Fire metoder der giver absolut stabilitet

1. Skruer, der isættes med lag-teknik
- 2. Kompressionsskinner**
3. Tension band
4. Buttress

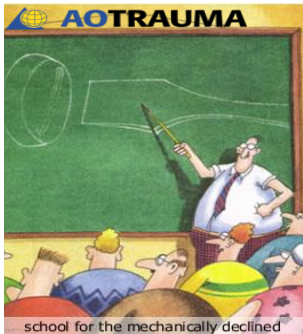
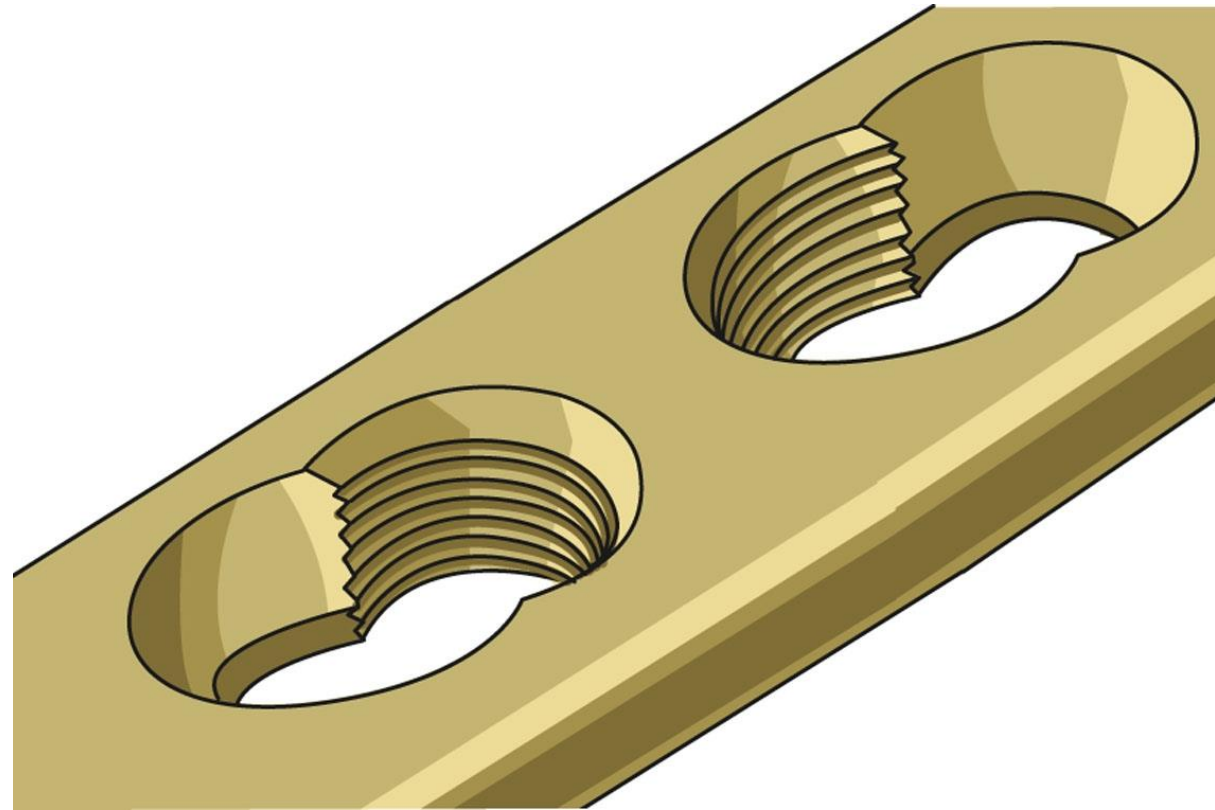

## 2. Kompressionsskinne

- Kan anvendes hvor lag-princip ikke kan opnås med skrue fx tværfrakturer
- Skinner med indbygget kompressionsfunktion

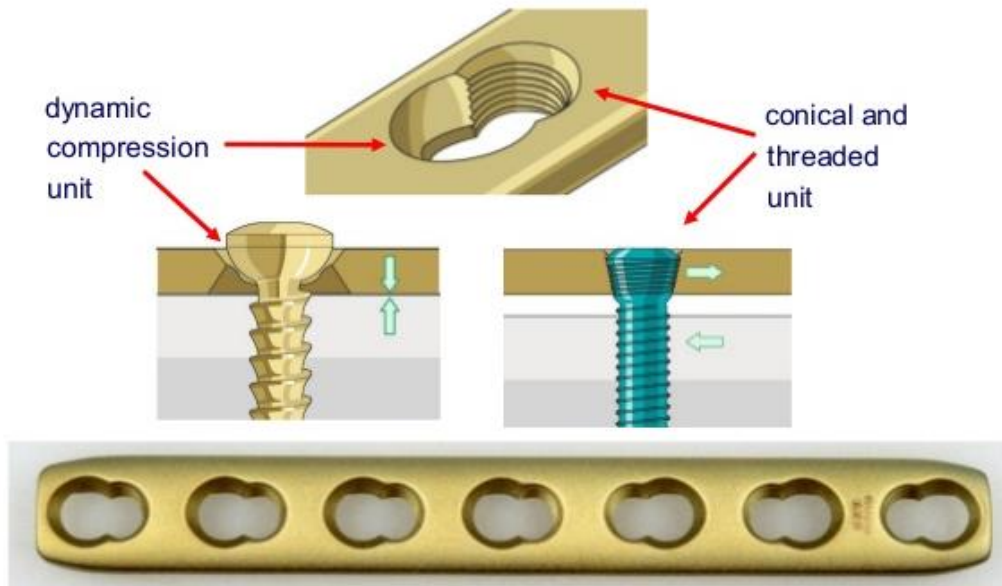

## 2. Kompressionsskinnne (fx LCP skinnen)

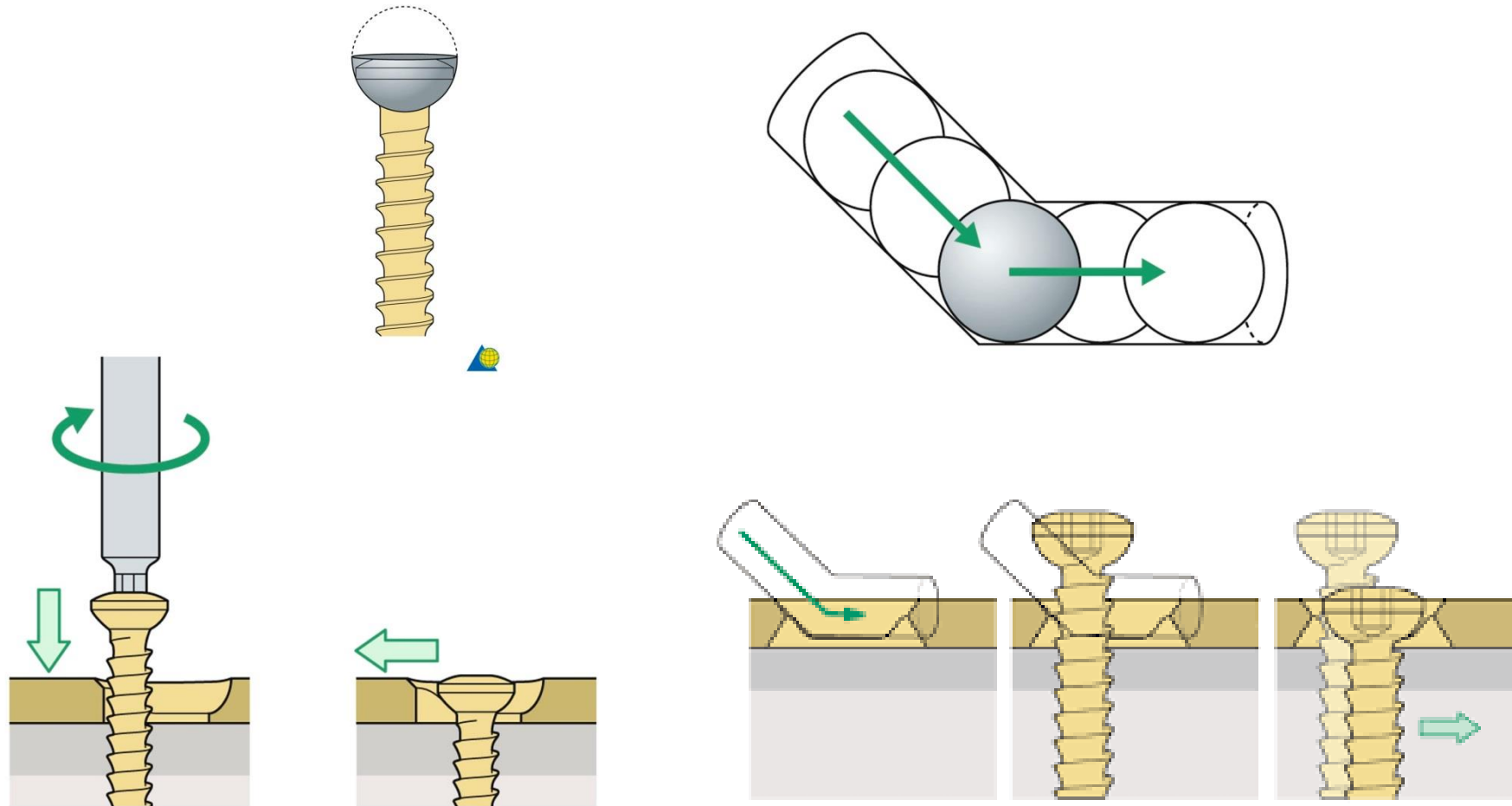

## 2. Kompression over skinne:

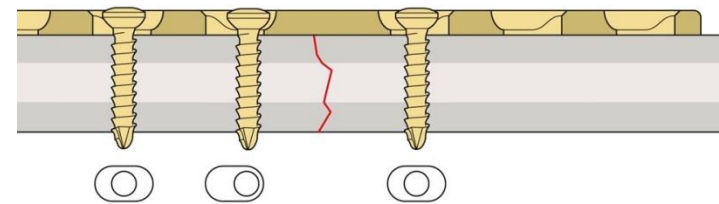
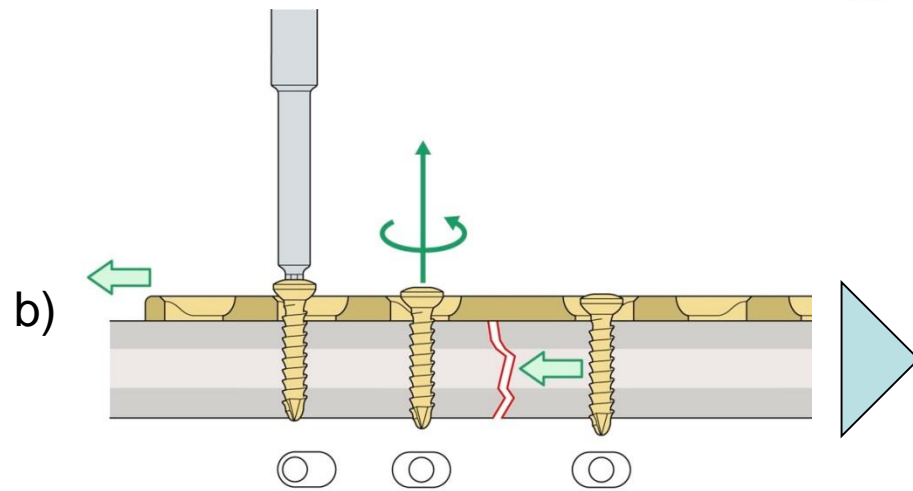
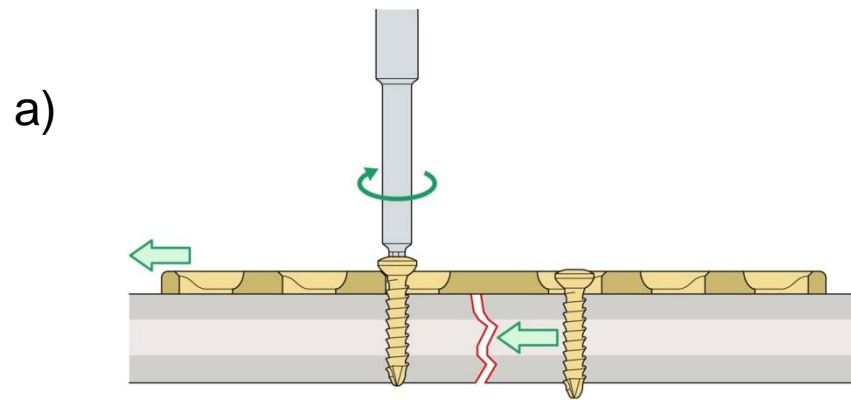

# Fire metoder til at opnå absolut stabilitet

1. Skruer, der isættes med lag-teknik
2. Kompressionsskinner
- 3. Tension band**
4. Buttress

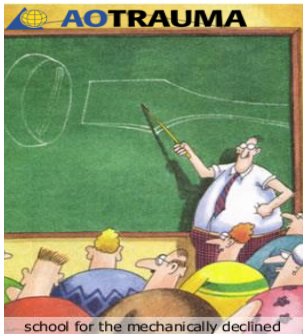
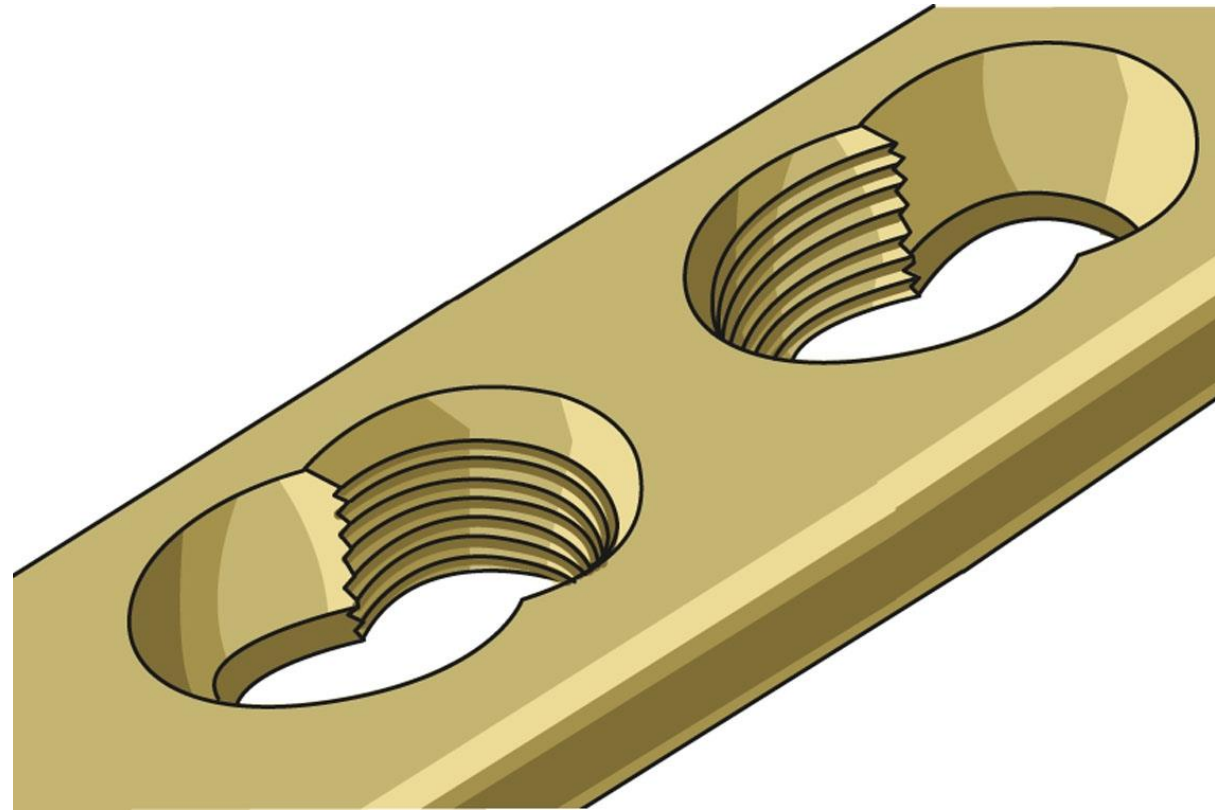

### 3. Tension band

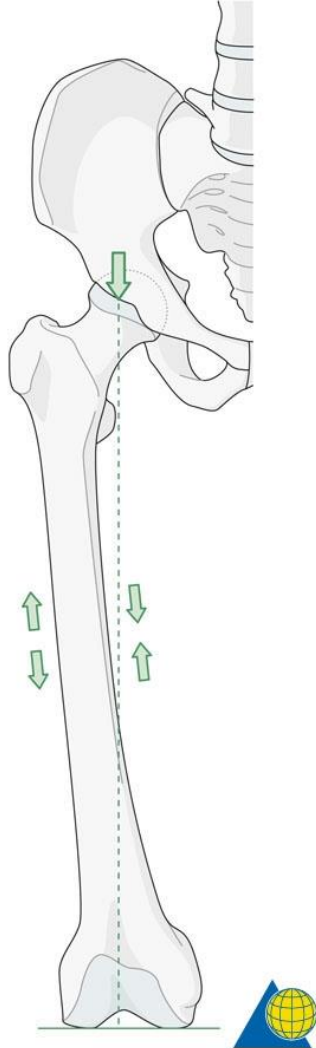



### 3. Tension band

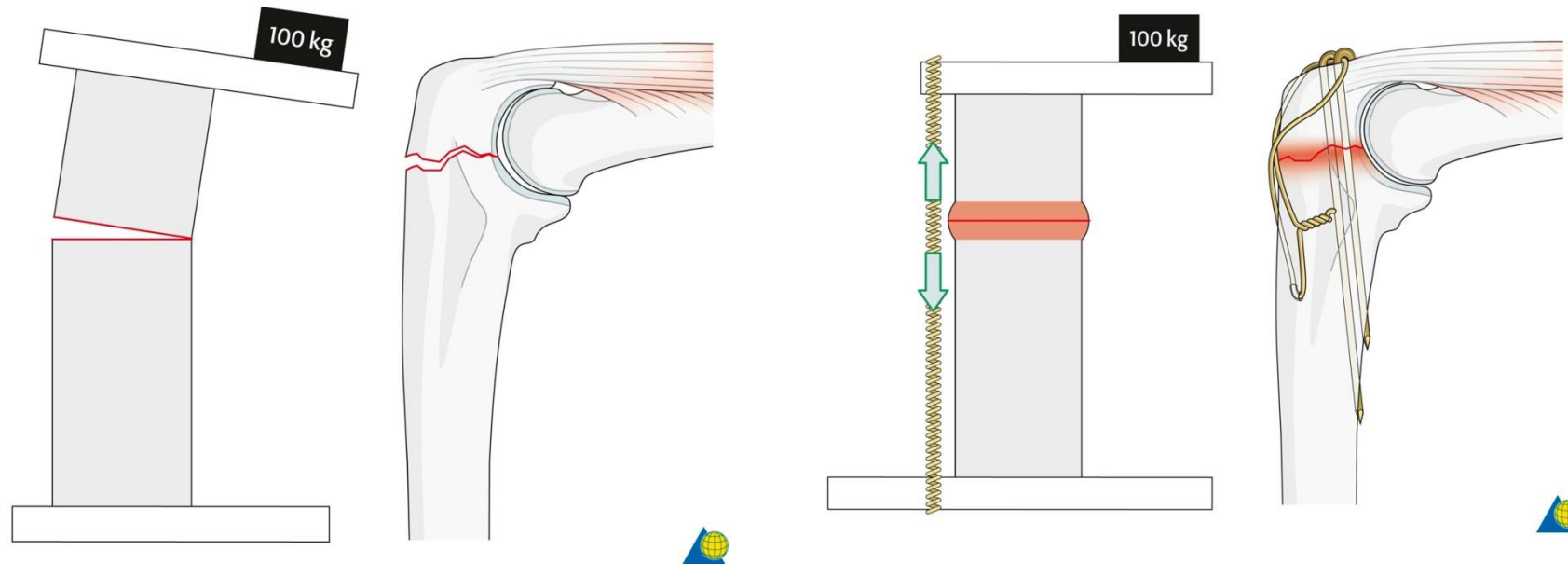

- Omsætter muskeltræk eller vægtbæring til interfragmentær kompression
- Giver dynamisk kompression

# Fire metoder til at opnå absolut stabilitet

1. Skruer, der isættes med lag-teknik
2. Kompressionsskinner
3. Tension band
4. **Buttress**



## 4. Buttress?

Ikke butt rest, men  
afstivning



## 4. Buttress eller anti-glide

- Låser for bevægelse udført af skæringskræfter
- Og omsætter skæringskræfter til interfragmentær kompression

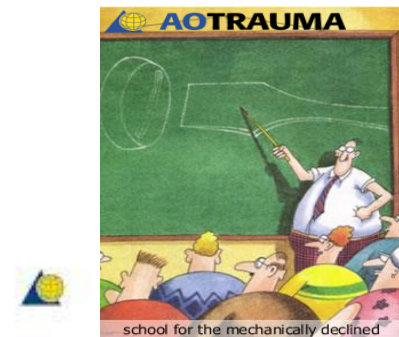
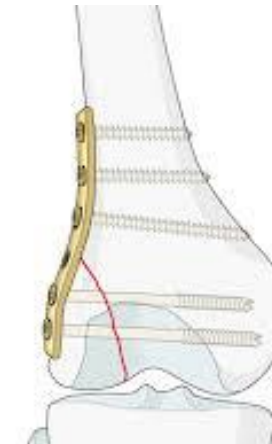
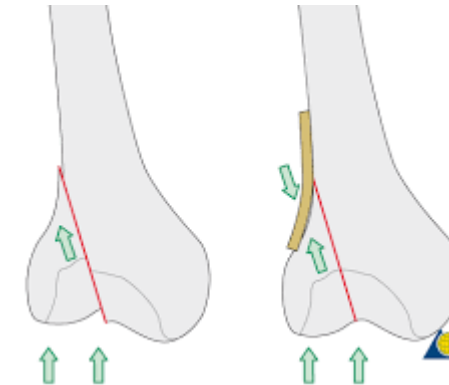
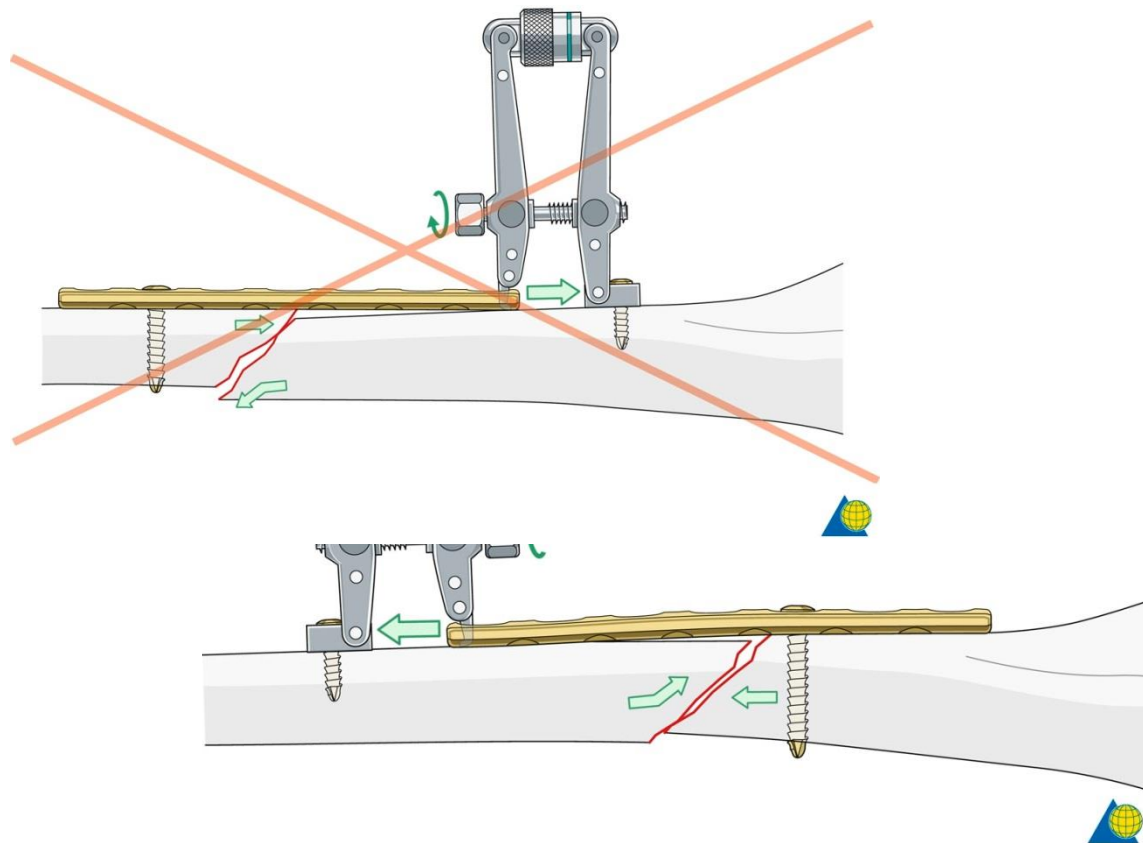

# Hvad har I lært nu?

- Absolut stabilitet er et osteosynteseprincip man vælger at bruge  
-> brugt korrekt medfører det direkte knogleheling uden callus
- Absolut stabilitet opnås ved at skabe
  - Interfragmentær kompression og
  - ...rigid fiksering...og er derfor velegnet til simple frakturer
- Man kan opnå absolut stabilitet på flere måder:
  - Lag princip
  - Kompressionsskinne
  - Tension band
  - Buttress

